



YueQing Yulin Electronic Co., Ltd

Adds:F/6 No.19 Ke'aisi Road, Xiangyang industrial Zone,Liushi Town,YueQing City, Zhejiang Province, China 325600

Website: www.indicatorlight.com Tel: 0577-62768130 Fax: 0577-62768130

SPECIFICATION FOR APPROVAL

规格说明书

CUSTOMER'S CODE

本厂代码: FL-PZ-W2016-1-5

DESCRIPTION

品名: 塑料信号灯plastic signal light

SPECIFICATION

规格: 10mm

DATE

编制日期: 2019-12-24

PART NO.

本厂型号: FL1P-10NJ-4

REFERENCE No.

档案编号: FL-PZ-W2016-1-5-090

Approved By Customer 编制	Qualified By 审核	Form Designer 批准



YueQing Yulin Electronic Co., Ltd

Adds:F/6 No.19 Ke'aisi Road, Xiangyang industrial Zone,Liushi Town,YueQing City, Zhejiang Province, China 325600

Website: www.indicatorlight.com Tel: 0577-62768130 Fax: 0577-62768130

1. 描述Description :

2. 图片Picture :



3. 图纸drawing

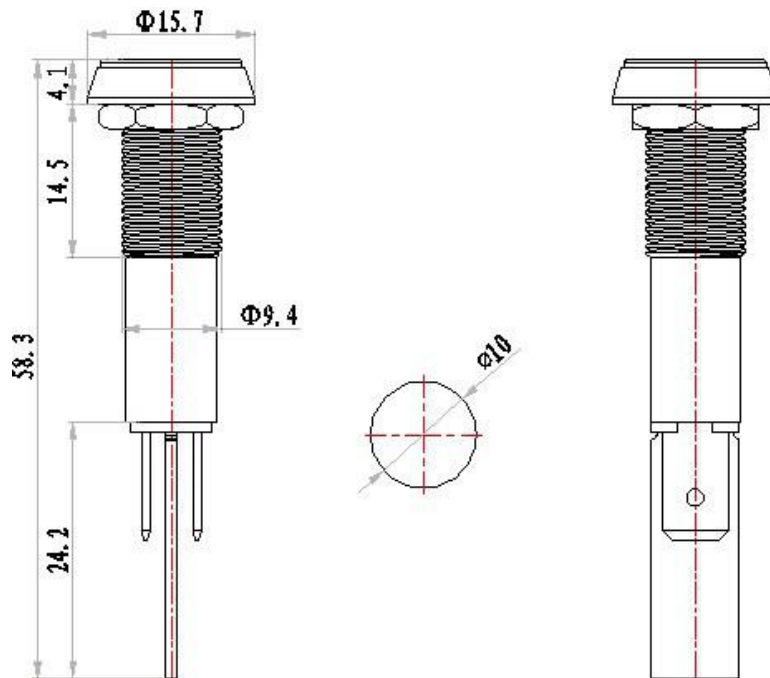



YueQing Yulin Electronic Co., Ltd

Adds:F/6 No.19 Ke'aisi Road, Xiangyang industrial Zone,Liushi Town,YueQing City, Zhejiang Province, China 325600

Website: www.indicatorlight.com Tel: 0577-62768130 Fax: 0577-62768130

3配件材料component material

4性能参数performance parameter

配件名Component name	材料material
灯罩 shell	PC plastic
Plastic shell塑料壳	ABS 工程塑料 ABS engineering plastic
塑料装饰Plastic decoration	
金属装饰metal decoration	H59 黄铜 or 204 不锈钢 H59 brass or 204 stainless steel
防水垫圈	
金属安装螺帽metal nut	H59黄铜 H59 nickel plated brass
塑料安装螺帽plastic nut	
灯座 lens	PA66尼龙 PA66 Nylon
发光源 light source	LED
电阻resistor	金属膜电阻Metal film
导线导线 Cable	
插件plug-in	C2680环保铜 ROHS copper

项目items	参数parameter
额定电压 Rated voltage	3V-780V DC or AC
额定电流 rated current	20mA
额定功率 rated power	0.2W
绝缘耐压 Insulation and voltage resistance	1800V
工作寿命 working life	100000h
电气寿命 electrical life	100000次
耐寒 cold-resistant	-40°C
耐热 heat-resisting	80°C

FILN 飞林

YueQing Yulin Electronic Co., Ltd

Adds:F/6 No.19 Ke'aisi Road, Xiangyang industrial Zone,Liushi Town,YueQing City, Zhejiang Province, China 325600

Website: www.indicatorlight.com Tel: 0577-62768130 Fax: 0577-62768130

4.详细图片 Detailed Picture :

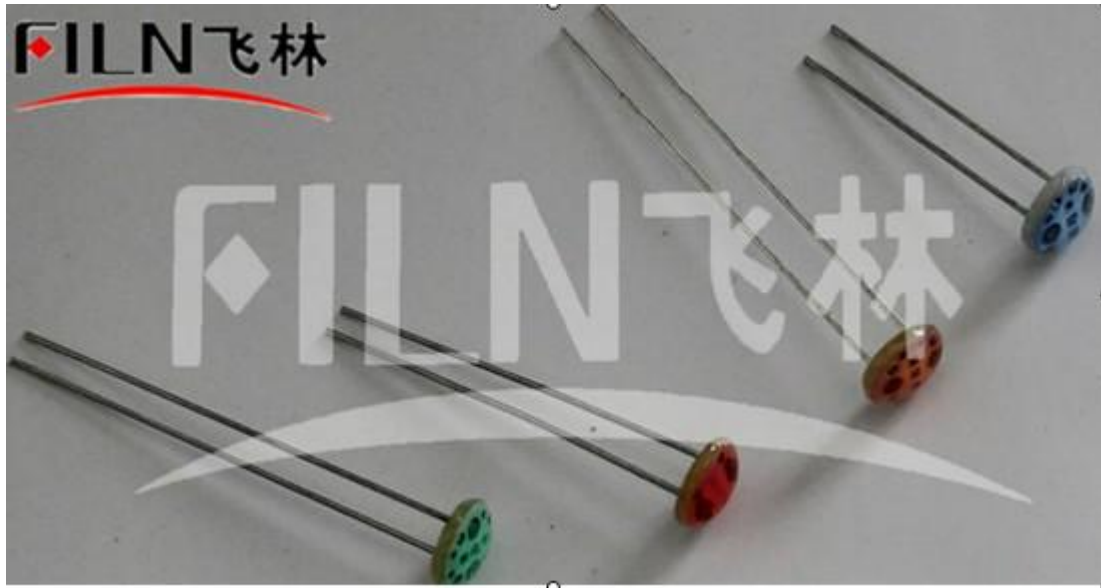

5.LED说明 Specification:

■ Emitter 外型图

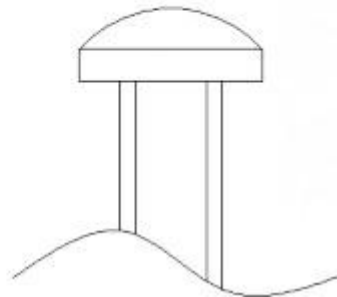
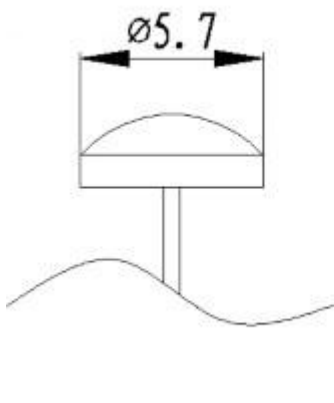

Spatial Distrbution

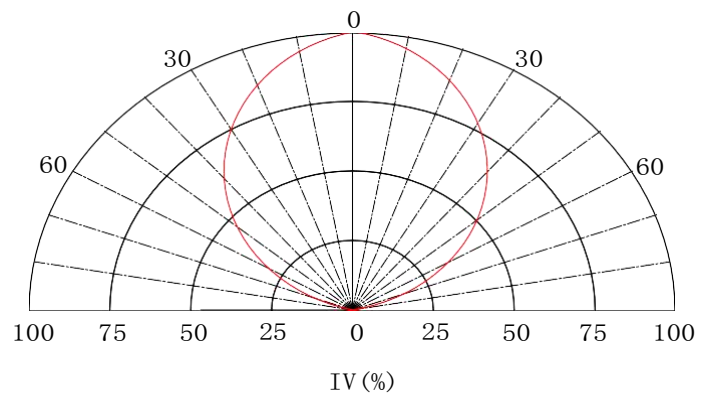



YueQing Yulin Electronic Co., Ltd

Adds:F/6 No.19 Ke'aisi Road, Xiangyang industrial Zone,Liushi Town,YueQing City, Zhejiang Province, China 325600

Website: www.indicatorlight.com Tel: 0577-62768130 Fax: 0577-62768130

■ Absolute Maximum Rating 极限工作参数

参数 Parameter	符号 Symbol	单位 Unit	极限参数 Maximum Rating
耗散功率 Power Dissipation	P	MW	60
连续正向电流 Continuous Forward Current	I _F	MA	25
反向电压 Reverse Voltage	V _R	V	5
工作温度范围 Operating Temperature Range	Top	°C	-25 to +80
存放温度范围 Storage Temperature Range	Tst	°C	-25 to +90
最高焊接温度 Soldering Temperature	Tso	°C	260 (for 5 second)

*Ifp Conditions: Pulse Wide≤10msec≤1/10 瞬间脉冲电流

*Tsol Conditions:3mm from the base of epoxy bulb 最高焊接温度 距胶体3mm

Typical electrical-optical Characteristics curves

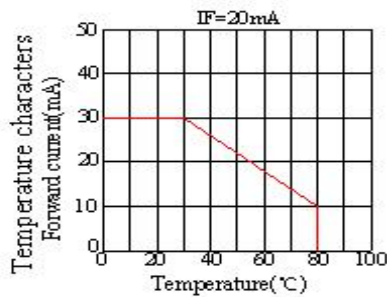
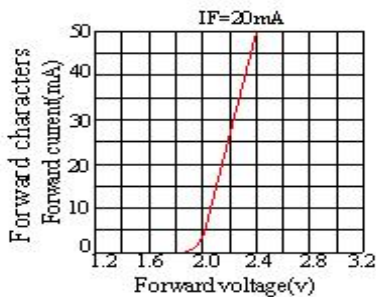

Notes:

The data are an typical presentation of the product,Contact customer service for details of technical information and warranty.
The product is sensitive to static antistatic operation environment is recommended
Products are shipped in either bulk bag package or taping.

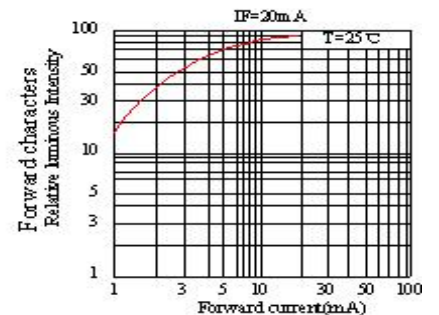
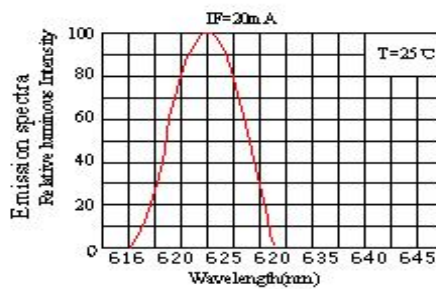
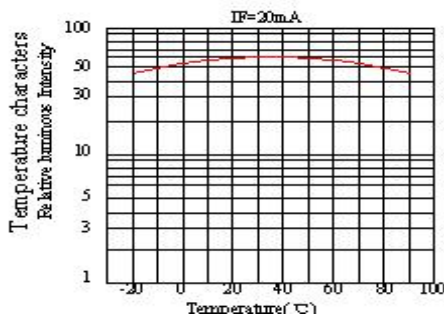

■ Typical Optical/Electrical Characteristics 光电特性参数

Color parameters 色参数		Optical Brightness 光亮度	0.00 cd/m ²
Main Wavelength 主波长	520.7.0 nm	light intensity 光强度	1000 mcd
Peak Wavelength 峰值波长	632.2 nm	luminous flux 光通量	4.8 lm
Peak width 峰值带宽	21.3 nm	luminous power 光功率	0.32 mW
colour coordinates xy 色坐标xy	(.1404.7126)	luminous efficacy 发光效率	56.81 lm/W
colour coordinates u'v' 色坐标u'v'	(.0498.5690)	forward current 正向电流	20.00 mA
colour purity 色纯度	0.758	alternating voltage 交流电压	4.22 V
Color temperature 色温	8400k	AC power 交流电功率	0.084 W

Notes:

- 1.Work absolute ratings Ta=25°C humidity=60% 工作常规值 温度=25°C 湿度=60%
- 2.Tolerance of measurement of forward voltage±0.1V 正向电压误差范围±0.1V
- 3.Test Machine: SSP6612 series LED test system



YueQing Yulin Electronic Co., Ltd

Adds:F/6 No.19 Ke'aisi Road, Xiangyang industrial Zone,Liushi Town,YueQing City, Zhejiang Province, China 325600

Website: www.indicatorlight.com Tel: 0577-62768130 Fax: 0577-62768130

LED LAMP RELIABILITY

• Test Items And Results

* Refer to reliability test standard specification for in this line.

Type	Test Item	REF. Standard	Test Condition	Note	Number of Damaged
Environmental Sequence	Temperature Cycle	JIS C 7021 (1997) A-4	-20°C→25°C→80°C→ 25°C 30mins,5mins,30mins,5mins	100 cycles	0/100
	High Humidity Heat Cycle	JIS C 7021 (1997) A-5	30°C→65°C 90%RH 24hrs/1cycle	10 cycles	0/100
	High Temperature	JIS C 7021 (1997) B-10	Ta=80°C	1000hrs	0/100
	Humidity Heat Storage	JIS C 7021 (1997) B-11	Ta=60°C RH=90%	1000hrs	0/100
	Low Temperature	JIS C 7021 (1997) B-12	Ta= -30°C	1000hrs	0/100
Operation Sequence	Life Test	JIS C 7035 (1985)	Ta=25°C If=20mA	1000hrs	0/100
	High Humidity Heat Life Test	*	60°C RH=90% If=20mA	500hrs	0/100
	Low Temperature Life test	*	Ta= -20°C If=20mA	1000hrs	0/100
Destructive Sequence	Resistance to Soldering Heat	JIS C 7021 (1997) A-11	Tsol=260 ± 5°C,10sec (3mm from the base of the epoxy bulb)	1 time	0/20
	Solder ability	JIS C 7021 (1997) A-2	Tsol=235 ± 5°C,5sec (Using flux)	1 time (over 95%)	0/20
	Lead Pull/Bend Test	JIS C 7021 (1997)A-11	Load 2.5N (0.25kgf) 0°→90°→0° Bending 3 times	No noticeable damage	0/20

● Criteria for Judging The Damage

Item	Symbol	Test Condition	Criteria for Judgment	
			M in.	M ax.
Forward Voltage	V _F	I _F =20mA	---	Initial data x 1.1
Reverse Current	I _R	V _R = 5V	---	Initial data x 2.0
Luminous Intensity	I _v	I _F =20mA	Initial data x 0.7	---

6. 电阻说明 Resistor Specification (RMS 1/4W 200kΩ):

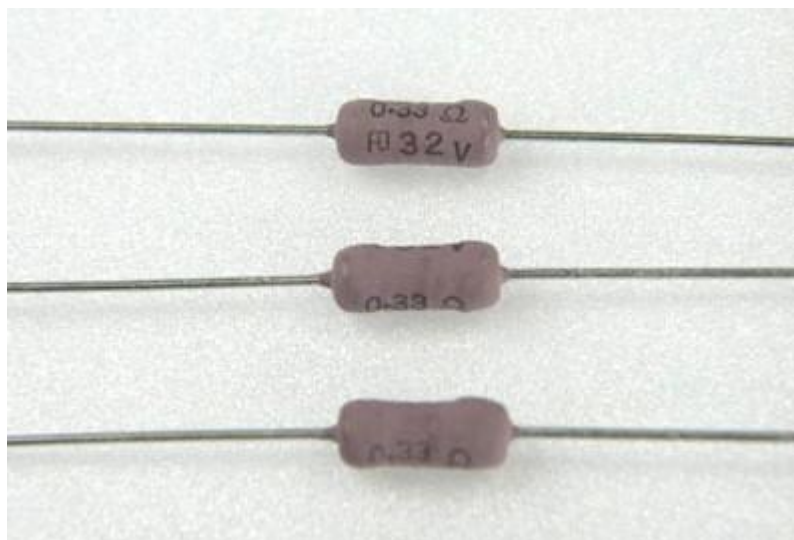

CHARACTERISTICS 性能

ITEM 项目	SPEC 规格	REMARKS 备注
Load life under high temperature 高温负荷寿命	±1.5%	JIS C 5201-1 (4.25.1) Rated voltage at 70°C for 1,000 hours 额定电压70°C 1,000小时
Load life under high humidity 耐湿负荷寿命	±5%	JIS C 5201-1 (4.24) Rated voltage at 40°C,95% RH for 1,000 hours 额定电压40°C,95% RH 1,000小时
Temp. coeff of resistance 温度系数	< 1K= ±500 PPM/°C ≤ 100KΩ=±300 ppm/°C >100KΩ=±200 ppm/°C	JIS C 5201-1 Room temp. + 100°C, 30min 室温 + 100°C, 30分钟
Short time overload 短时间过负荷	±1%	JIS C 5201-1 (4.13) 6.25 times the rated power for 5 seconds 6.25倍额定功率 5秒
Temperature cycling 温度循环	±1%	JIS C 5201-1 (4.19) 5 cycles for -25°C±3°C(30min); room temp.(30min) ~ +85°C±3°C(30min) room temp. (30min)
Resistance to soldering heat 焊锡耐热	±1%	JIS C 5201-1 (4.18) 260°C±5°C for 10 seconds(焊锡槽) 350°C±10°C for 3.5 seconds(手焊锡)
Insulation resistance 绝缘电阻	>1,000MΩ	JIS C 5201-1 (4.6.1.1) 500 volt Insulation test 1min 500 V绝缘测试电压1分钟

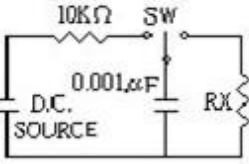
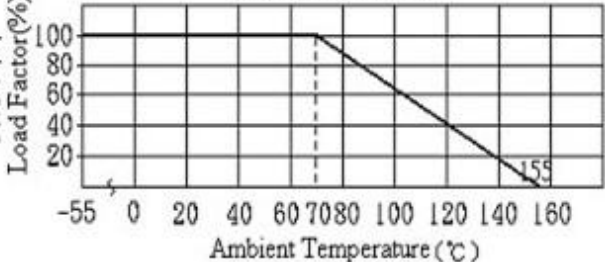
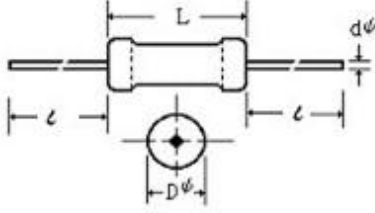
<p>Pulse withstanding voltage 脉冲</p>	<p>±20%</p>	<p>■The following discharge cycle is repeated in the circuit of the left fig. 2.5 sec. ON 2.5 sec. OFF 50 cycles. With following DC pulse test voltage</p> <p>■ Pulse voltage:1/6W,S1/4W: 3KV. ≥1/4W: 100KΩ: (3KV); 100KΩ-620KΩ: (5KV); > 620KΩ: (10KV)</p> 
<p>DERATING CURVE 额定功率下降曲线</p> 		
<p>Various type of forming & taping are available</p>		<p>提供插装的造型与带装</p>
<p>Coating color: RMU1/4W,RMU1/6W、dark blue, other、pink。</p>		<p>涂装颜色: RMU1/4W,RMU1/6W蓝色,其他粉红色。</p>

■ CHARACTERISTICS 性能

Model 型名	Power Rating 额定功率 (W)	Resistance Range E-24 阻值范围 Ω	Maximum Working Voltage 最高使用电压	Dielectric Withstandi ng Voltage 耐电压	Dimension 尺寸 (mm)			
					L	D φ	t	d φ
RMU1/4W 、 RMS1/2W	1/4,1/2	10Ω ~ <100M	1600V	700V	6±0.3	2.4±0.1	28±2	0.6±0.05