



乐清市裕林电子有限公司

Yueqing Yulin Electrical Co., Ltd

Address: #19 Ke'aisi Road, Xiangyang industrial area, Liushi Town, Yueqing City, Zhejiang Province, China

Tel: 0577-27878383-8029

Fax: 0577-27878383-8027

website: WWW.FILN.COM

SPECIFICATION FOR APPROVAL

规格说明书

CUSTOMER'S CODE

本厂代码:

DESCRIPTION

品名: FLM22-FJ-6-C 凹头环形大电流插脚
自复自锁金属按钮

SPECIFICATION

规格: 22mm

DATE

编制日期:

PART NO.

本厂型号:

REFERENCE No.

档案编号:

Approved By Customer 编制	Qualified By 审核	Form Designer 批准



乐清市裕林电子有限公司

Yueqing Yulin Electrical Co., Ltd

Address: #19 Ke'aisi Road, Xiangyang industrial area, Liushi Town, Yueqing City, Zhejiang Province, China

Tel: 0577-27878383-8029

Fax: 0577-27878383-8027

website: WWW.FILN.COM

1. 图片 Picture:



2. 图纸 drawing

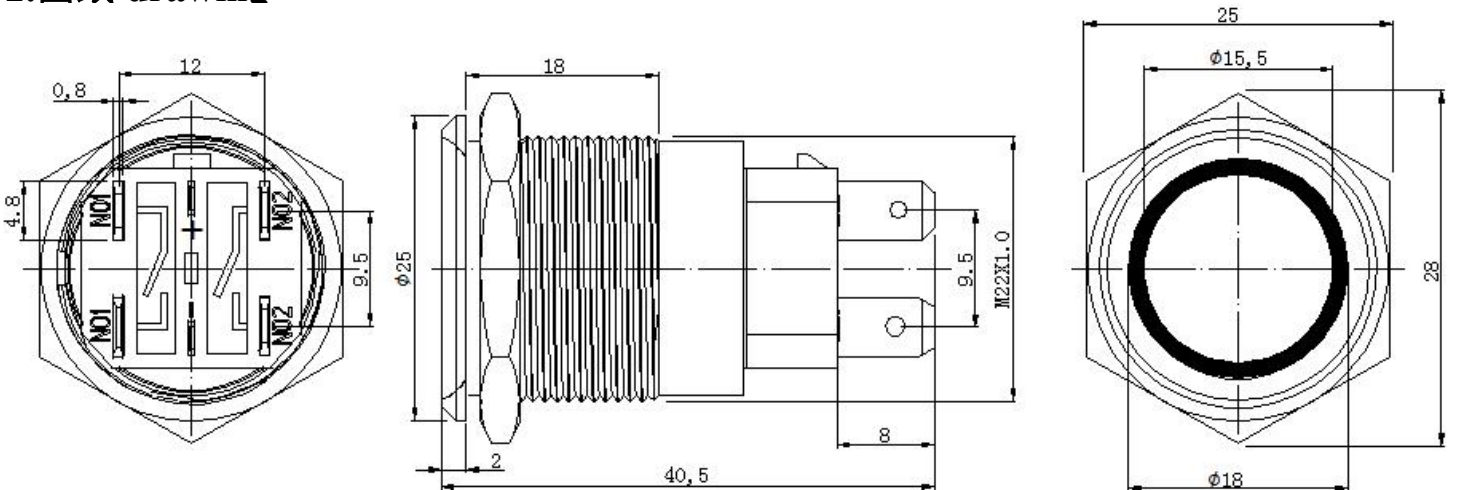

电气简图

安装孔图

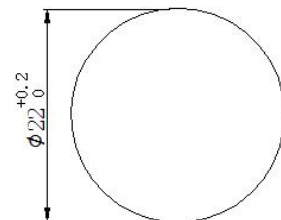
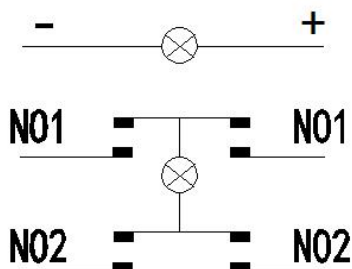



乐清市裕林电子有限公司

Yueqing Yulin Electrical Co., Ltd

Address: #19 Ke'aisi Road, Xiangyang industrial area, Liushi Town, Yueqing City, Zhejiang Province, China

Tel: 0577-27878383-8029

Fax: 0577-27878383-8027

website: WWW.FILN.COM

3 配件材料 component material

配件名 Component name	材料 material
导光按键 Light Guide button	PC 塑料 PC plastic
按键 Press the button	304 不锈钢/6063 铝合金 04 stainless steel/6063 aluminum alloy
外壳套筒 Shell sleeve	H59黄铜/304不锈钢 /6063铝合金 H59 brass/304 stainless steel/6063 aluminum alloy
按钮引脚 Button pin	H62 铜合金 H62 brass
防水圈 rubber ring	SIL 硅胶 SIL silica gel
螺帽 nut	H59 黄铜 H59 brass
底座 housing	PA66+GF20%阻燃尼龙 PA66+GF20% nylon
光源 Light source	LED 灯珠 LED
电阻 Resistor	金属膜电阻 Metal film
触点 Contact points	银触点 AgCd012

4 性能参数 performance parameter

项目 items	参数 parameter
开关额定电压 Rated voltage	36V DC 250V AC
开关额定电流 rated current	20A DC 20A AC
指示灯额定电压 LED voltage rating	3V-380V
指示灯额定电流 Led rated current	≤20mA
额定功率 rated power	720W (DC) 5000W (AC)
绝缘耐压 Insulation and voltage resistance	3000V
接触电阻: Point resistanc:	≤50mΩ
绝缘电阻: Isolation resistance:	≥1000MΩ
机械寿命 Mechanical life	20 万次
电气寿命 electrical life	5-8 万次 (250V/16A) 2-3 万次 (250V/20A)
工作环境温度 Operating temperature	-25℃~+85℃
防护等级(头部) IP degree	IP66 IK09
指示灯颜色 LED color	红蓝绿黄白色 R/B/G/Y/W



乐清市裕林电子有限公司

Yueqing Yulin Electrical Co., Ltd

Address: #19 Ke'aisi Road, Xiangyang industrial area, Liushi Town, Yueqing City, Zhejiang Province, China

Tel: 0577-27878383-8029

Fax: 0577-27878383-8027

website: WWW.FILN.COM

4. Detailed Picture :



5.LED Specification:

■ Emitter 外型图

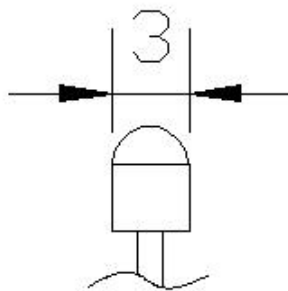

Spatial Distribution

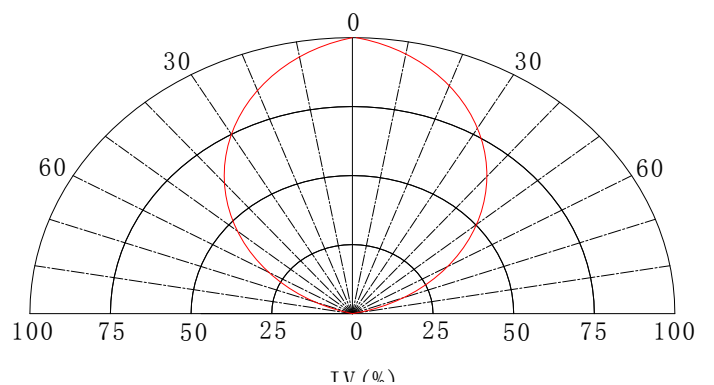



乐清市裕林电子有限公司

Yueqing Yulin Electrical Co., Ltd

Address: #19 Ke'aisi Road, Xiangyang industrial area, Liushi Town, Yueqing City, Zhejiang Province, China

Tel: 0577-27878383-8029

Fax: 0577-27878383-8027

website: WWW.FILN.COM

■ Absolute Maximum Rating 极限工作参数

参数 Parameter	符号 Symbol	单位 Unit	极限参数 Maximum Rating
耗散功率 Power Dissipation	P	MW	60
连续正向电流 Continuous Forward Current	I _F	MA	25
反向电压 Reverse Voltage	V _R	V	5
工作温度范围 Operating Temperature Range	Top	°C	-25 to +80
存放温度范围 Storage Temperature Range	Tst	°C	-25 to +90
最高焊接温度 Soldering Temperature	Tso	°C	260 (for 5 second)

*Ifp Conditions: Pulse Wide ≤ 10msec ≤ 1/10

瞬间脉冲电流

*Tsol Conditions: 3mm from the base of epoxy bulb 最高焊接温度 距胶体 3mm

Typical electrical-optical Characteristics curvers

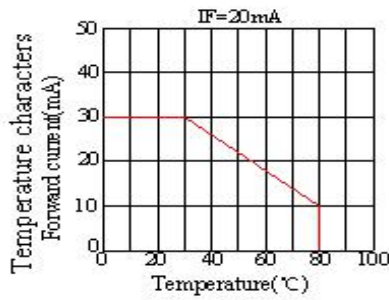
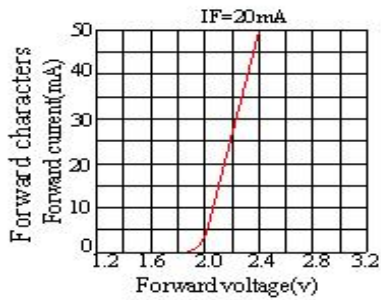

Notes:

The data are an typical presentation of the product, Contact customer service for details of technical information and warranty.

The product is sensitive to static antistatic operation environment is recommended

Products are shipped in either bulk bag package or taping.

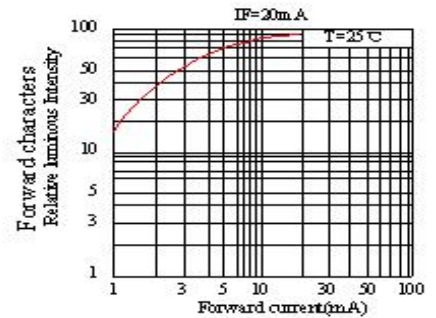
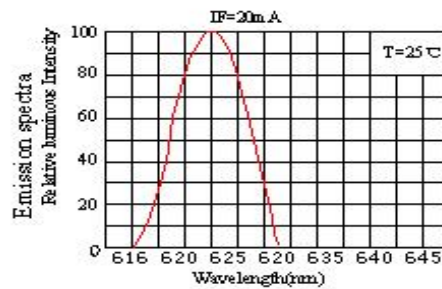
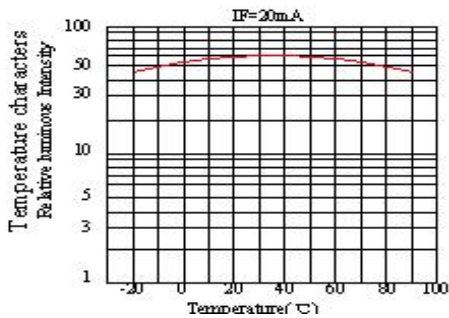



乐清市裕林电子有限公司

Yueqing Yulin Electrical Co., Ltd

Address: #19 Ke'aisi Road, Xiangyang industrial area, Liushi Town, Yueqing City, Zhejiang Province, China

Tel: 0577-27878383-8029

Fax: 0577-27878383-8027

website: WWW.FILN.COM

Typical Optical/Electrical Characteristics 光电特性参数

Color parameters 色参数		Optical Brightness 光亮度	0.00 cd/m ²
Main Wavelength 主波长	520.7.0 nm	light intensity 光强度	1000 mcd
Peak Wavelength 峰值波长	632.2 nm	luminous flux 光通量	4.8 lm
Peak width 峰值带宽	21.3 nm	luminous power 光功率	0.32 mW
colour coordinates xy 色坐标 xy	(.1404.7126)	luminous efficacy 发光效率	56.81 lm/W
colour coordinates u'v' 色坐标 u'v'	(.0498.5690)	forward current 正向电流	20.00 mA
colour purity 色纯度	0.758	alternating voltage 交流电压	4.22 V
Color temperature 色温	8400k	AC power 交流电功率	0.084 W

Notes:

1. Work absolute ratings Ta=25°C humidity=60% 工作常规值 温度=25°C 湿度=60%
2. Tolerance of measurement of forward voltage±0.1V 正向电压误差范围±0.1V
3. Test Machine: SSP6612 series LED test system



乐清市裕林电子有限公司

Yueqing Yulin Electrical Co., Ltd

Address: #19 Ke'aisi Road, Xiangyang industrial area, Liushi Town, Yueqing City, Zhejiang Province, China

Tel: 0577-27878383-8029

Fax: 0577-27878383-8027

website: WWW.FILN.CO

LED LAMP RELIABILITY

Type	Test Item	REF. Standard	Test Condition	Note	Number of Damaged
Environmental Sequence	Temperature Cycle	JIS C 7021 (1697) A-4	-20℃→25℃→80℃→25℃ 30mins,5mins,30mins,5mins	100 cycles	0/100
	High Humidity Heat Cycle	JIS C 7021 (1697) A-5	30℃→65℃ 90%RH 24hrs/1cycle	10 cycles	0/100
	High Temperature Storage	JIS C 7021 (1697) B-10	Ta=80℃	1000hrs	0/100
	Humidity Heat Storage	JIS C 7021 (1697) B-11	Ta=60℃ RH=90%	1000hrs	0/100
	Low Temperature Storage	JIS C 7021 (1697) B-12	Ta= -30℃	1000hrs	0/100
Operation Sequence	Life Test	JIS C 7035 (1685)	Ta=25℃ If=20mA	1000hrs	0/100
	High Humidity Heat Life Test	*	60℃ RH=90% If=20mA	500hrs	0/100
	Low Temperature Life test	*	Ta= -20℃ If=20mA	1000hrs	0/100
Destructive Sequence	Resistance to Soldering Heat	JIS C 7021 (1697) A-11	Tsol=260 ± 5℃,10sec (3mm from the base of the epoxy bulb)	1 time	0/20
	Solder ability	JIS C 7021 (1697) A-2	Tsol=235 ± 5℃,5sec (Using flux)	1 time (over 95%)	0/20
	Lead Pull/Bend Test	JIS C 7021 (1697)A-11	Load 2.5N (0.25kgf) 0°→90°→0° Bending 3 times	No noticeable damage	0/20

● Test Items And Results

* Refer to reliability test standard specification for in this line.

● Criteria for Judging The Damage

Item	Symbol	Test Condition	Criteria for Judgment	
			Min.	Max.
Forward Voltage	V _F	I _F =20mA	---	Initial data x 1.1
Reverse Current	I _R	V _R = 5V	---	Initial data x 2.0
Luminous Intensity	I _V	I _F =20mA	Initial data x 0.7	---



乐清市裕林电子有限公司

Yueqing Yulin Electrical Co., Ltd

Address: #19 Ke'aisi Road, Xiangyang industrial area, Liushi Town, Yueqing City, Zhejiang Province, China

Tel: 0577-27878383-8029

Fax: 0577-27878383-8027

website: WWW.FILN.COM

6. Resistor Specification (RMS 1/4W 200kΩ):

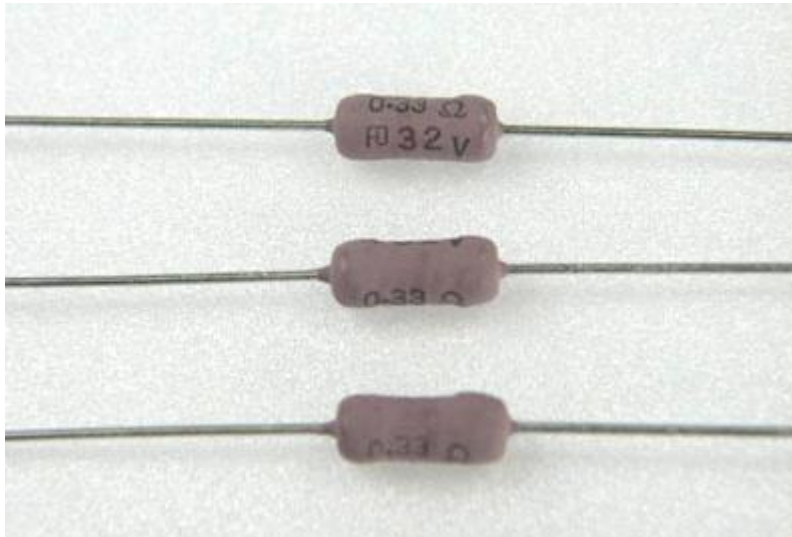

CHARACTERISTICS 性能

ITEM 项目	SPEC 规格	REMARKS 备注
Load life under high temperature 高温负荷寿命	±1.5%	JIS C 5201-1 (4.25.1) Rated voltage at 70°C for 1,000 hours 额定电压70°C 1,000小时
Load life under high humidity 耐湿负荷寿命	±5%	JIS C 5201-1 (4.24) Rated voltage at 40°C,95% RH for 1,000 hours 额定电压40°C,95% RH 1,000小时
Temp. coeff of resistance 温度系数	< 1K= ±500 PPM/°C ≤ 100KΩ=±300 ppm/°C >100KΩ=±200 ppm/°C	JIS C 5201-1 Room temp. + 100°C, 30min 室温 + 100°C, 30分钟
Short time overload 短时间过负荷	±1%	JIS C 5201-1 (4.13) 6.25 times the rated power for 5 seconds 6.25倍额定功率 5秒
Temperature cycling 温度循环	±1%	JIS C 5201-1 (4.19) 5 cycles for -25°C±3°C(30min); room temp.(30min) ~ +85°C±3°C(30min) room temp. (30min)
Resistance to soldering heat 焊锡耐热	±1%	JIS C 5201-1 (4.18) 260°C±5°C for 10 seconds(焊锡槽) 350°C±10°C for 3.5 seconds(手焊锡)
Insulation resistance 绝缘电阻	>1,000MΩ	JIS C 5201-1 (4.6.1.1) 500 volt Insulation test 1min 500 V绝缘测试电压1分钟

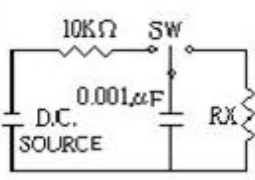
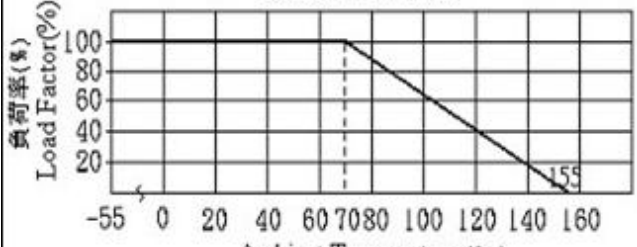
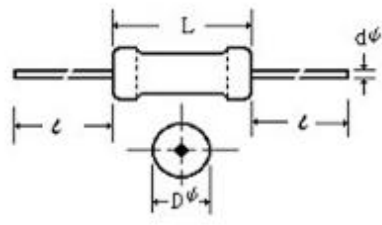
<p>Pulse withstanding voltage 脉冲</p>	<p>±20%</p>	<p>■The following discharge cycle is repeated in the circuit of the left fig. 2.5 sec. ON 2.5 sec. OFF 50 cycles. With following DC pulse test voltage ■ Pulse voltage:1/6W,S1/4W: 3KV. ≧1/4W: 100KΩ: (3KV); 100KΩ-620KΩ: (5KV); > 620KΩ: (10KV)</p> 
<p>DERATING CURVE 额定功率下降曲线</p> 		
<p>Various type of forming & taping are available</p>		
<p>提供插装的造型与带装</p>		
<p>Coating color: RMU1/4W,RMU1/6W、dark blue, other、pink。</p>		
<p>涂装颜色: RMU1/4W,RMU1/6W蓝色,其他粉红色。</p>		

■ CHARACTERISTICS 性能

Model 型名	Power Rating 额定功率 (W)	Resistance Range E-24 阻值范围 Ω	Maximum Working Voltage 最高使用 电压	Dielectric Withstandi ng Voltage 耐电压	Dimension 尺寸 (mm)			
					L	D φ	t	d φ
RMU1/4W 、 RMS1/2W	1/4,1/2	10Ω ~ <100M	1600V	700V	6±0.3	2.4±0.1	28±2	0.6±0.05